

INSTALLATION MANUAL

PRODUCT: FRONT ALUMINUM BUMPER

MODEL: MITSUBISHI L200 / TRITON (2019 - PRESENT)

PART NO: 2D.4011.1-NL



CAUTION!

To reduce the risk of serious injury or damage, please read and understand all instructions and procedures before attempting to install or use this product. Safety glasses must be worn at all times during installation or maintenance of this product. Ensure all mounting bolts are tensioned after 400 km and periodically thereafter.

NOTICE

Whilst the bumper adds additional protection to your vehicle, precautionary measures still need to be taken to avoid damage. Always drive to the conditions and your surroundings.

ADR69 COMPATIBLE
AIR BAG COMPLIANT

INSTALLATION MANUAL

PRODUCT: FRONT ALUMINUM BUMPER

MODEL: MITSUBISHI L200 / TRITON (2019 - PRESENT)

PART NO: 2D.4011.1-NL



TECHNICAL INFORMATION

*WINCH INSTALLATION

A winch with a pull capacity of up to 12000 lbs can be installed with the RIVAL Bumper. It is not advisable to exceed this pulling capacity since damage, injury or death may occur where the 12000 lbs recommended capacity is exceeded.

Winch measurements:

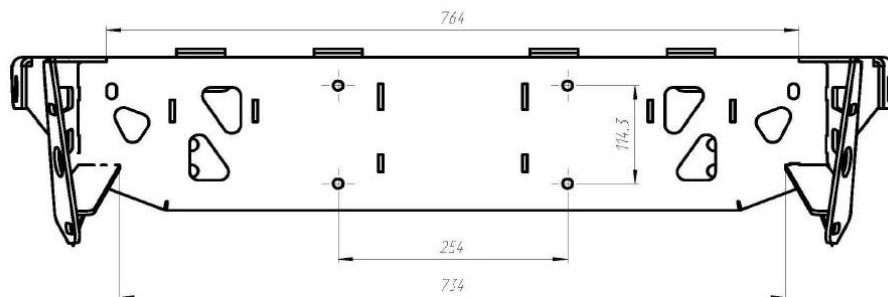

Winch size limits:

L 730 x W 220 mm x H 210 mm

INSTALLATION MANUAL

PRODUCT: FRONT ALUMINUM BUMPER

MODEL: MITSUBISHI L200 / TRITON (2019 - PRESENT)

PART NO: 2D.4011.1-NL



TECHNICAL INFORMATION

*RECOVERY POINTS



WARNING

Do not exceed the Working Load Limit of these recovery points or shackle.

INSPECTION AND SAFETY

Recovery of stuck vehicles can be dangerous. Always inspect the shackle and recovery points before each use. Do not use if there are visible signs of damage or wear including cracking (or elongation). Always stay a safe distance away from the recovery area - at least 1.5 times the length of the recovery strap. Incorrect use of receivers equipment can result in serious injury or death.

INSTALLATION MANUAL

PRODUCT: FRONT ALUMINUM BUMPER

MODEL: MITSUBISHI L200 / TRITON (2019 - PRESENT)

PART NO: 2D.4011.1-NL



FRONT BUMPER

Part number 2D.4011.1-NL

Suited to vehicle: MITSUBISHI L200 / Triton (2019 - PRESENT)

Material: Aluminum / Steel

Compatibility: RIVAL 4046.2 Skid Plate Mitsubishi L200 Triton 4WD (radiator) (2015-)



SAFETY NOTICE

* The RIVAL Bumper is designed to compliment the use and design of the specified vehicle under conditions specified by the vehicle manufacturer.

* While driving the vehicle at any speed, collision with any other vehicle, animal or object must always be avoided.

* Following any collision with any other vehicle, animal or object, the RIVAL Bumper and the vehicle must be inspected by a specialized or suitably qualified vehicle repairer for possible damage to the components and assemblies in order to confirm suitability for further use of the vehicle.

* It is strongly recommended that you do not operate a vehicle with a damaged bumper or its components. In the case of damage, please contact the nearest RIVAL dealer. Vehicle, or where the bumper has been damaged, is extremely dangerous and must be avoided at all cost.

* The operation of a vehicle where the bumper is not properly attached and fastened to the vehicle, or where the bumper has been damaged, is extremely dangerous and must be avoided at all cost.

* It is recommended that you carry out regular inspections of all the bumper elements such as all bolts, wires, connectors.

* A winch with a pull capacity of up to and including 12000 lb can be installed with the RIVAL Bumper. It is not advisable to

INSTALLATION MANUAL

PRODUCT: FRONT ALUMINUM BUMPER

MODEL: MITSUBISHI L200 / TRITON (2019 - PRESENT)

PART NO: 2D.4011.1-NL



PARTS LISTING

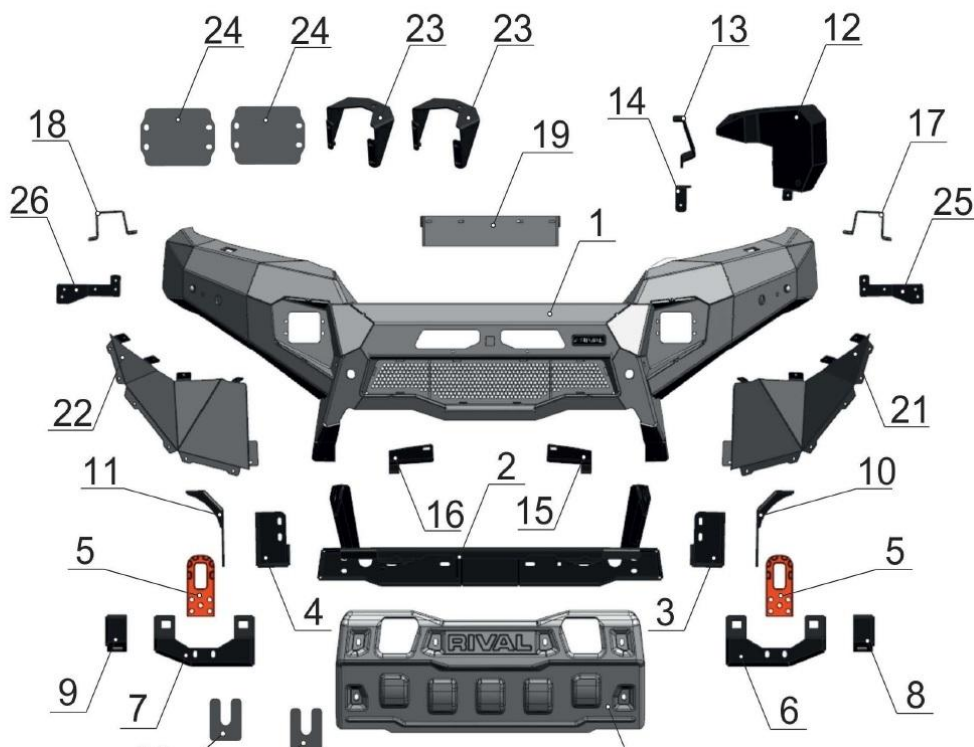

INSTALLATION MANUAL

PRODUCT: FRONT ALUMINUM BUMPER

MODEL: MITSUBISHI L200 / TRITON (2019 - PRESENT)

PART NO: 2D.4011.1-NL



PARTS LISTING

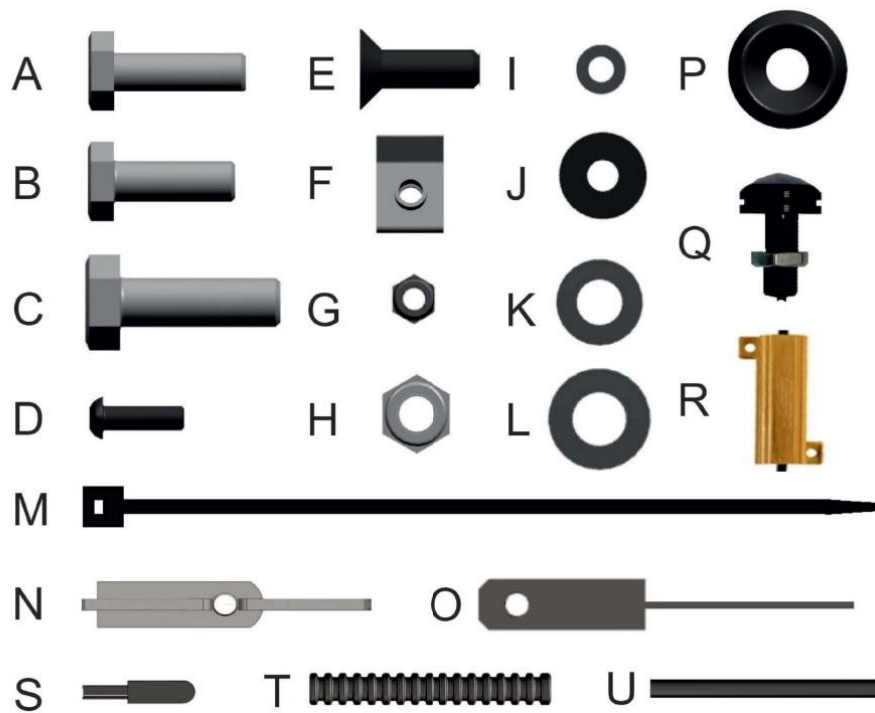

INSTALLATION MANUAL

PRODUCT: FRONT ALUMINUM BUMPER

MODEL: MITSUBISHI L200 / TRITON (2019 - PRESENT)

PART NO: 2D.4011.1-NL



INSTALLATION PROCEDURE

Preparation for installation



Fig.1

1. Open the hood. Disconnect terminal “-” from the vehicle battery (fig.1).



Fig.2

2. Remove the plastic pad clip. Dismantle the clip (fig.2).

*** Set aside for re-use later on.**



INSTALLATION PROCEDURE



Fig.7

7. Unscrew screws retaining wheel arches to OE bumper, on both sides of the vehicle (fig.7).



Fig.8

8. Remove plastic covers of OE bumper, on both sides of the vehicle (fig.8).



Fig.9

9. Unscrew screws retaining OE bumper to vehicle body (fig.9).



Fig.10

10. Detach bumper side plates from brackets on each side by pulling them (fig.10).



Fig.11

11. Unscrew 3 screws, in central part of the vehicle, retaining OE bumper to vehicle body (fig.11).

*** Set aside for re-use later on.**

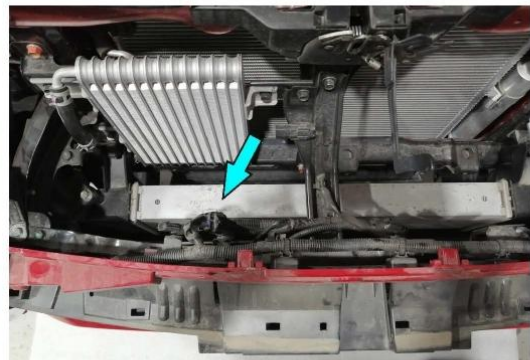

Fig.12

12. Disconnect wiring that attach OE bumper (fig.12).

INSTALLATION PROCEDURE



Fig.13

13. Remove OE bumper (fig.13).



Fig.14

14. Remove bottom brackets, by unscrewing 3 nuts on both sides of the vehicle (fig.14).
* Set aside for re-use later on.



Fig.15

15. Remove left plastic deflector, unfastening plastic clips (fig.15).



Fig.16

16. Remove right plastic deflector, unfastening plastic clips (fig.16).



Fig.17

17. Remove right bracket of OE bumper (fig.17).

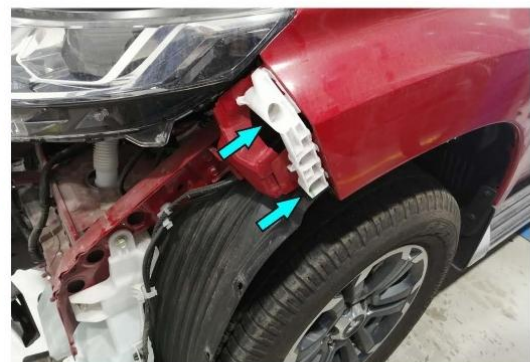

Fig.18

18. Remove side brackets of OE bumper, by unscrewing 2 screws on both sides of the vehicle (fig.18).

INSTALLATION PROCEDURE



Fig.19

19. Disconnect wiring from the washer pump and washer liquid level sensor (fig.19).



Fig.20

20. Disconnect washer pump pipe and wring out pipe, to be sure, there is no liquid leaking (fig.20).

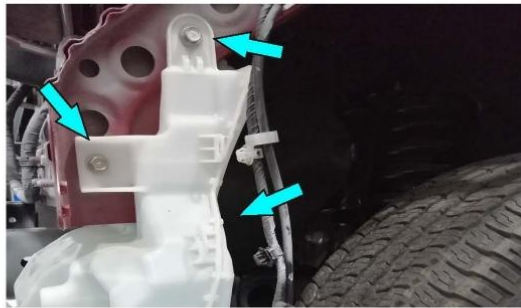

Fig.21

21. Remove washer tank reservoir by unscrewing bolts M6 (fig.21).

*** Set bolts aside for re-use later on.**



Fig.22

22. Remove washer tank reservoir filler by removing plastic clip (fig.22).

*** Set aside for re-use later on.**

Vehicle body cutting procedure



Fig.23

23. Cut off the safety beam side members, flush with the frame lateral surface, on both sides of the vehicle (fig.23).



Fig.24

24. Paint all trimming points, using paint, undercoating or any other corrosion resistance coating (fig.24).

INSTALLATION PROCEDURE

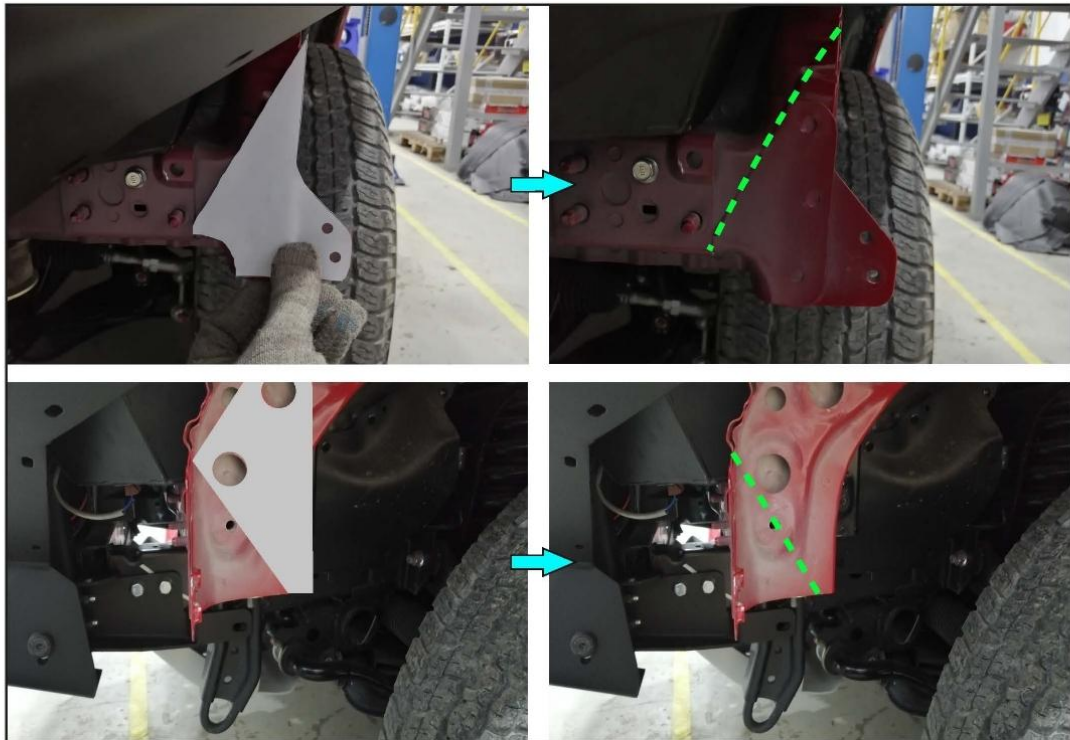

Fig.25

25. Prepare template 1 and template 2 from the end of this manual. Mark cutting lines using templates on both sides of the vehicle (fig.25).



Fig.26

26. Cut off vehicle body following marked lines on both sides of the vehicle (fig.26).



Fig.27

27. Paint all trimming points, using paint, undercoating or any other corrosion resistance coating (fig.27).

If it's necessary, you can replace parts of the vehicle body, that you cut on steps 25-27, using replacement brackets (item.25,26) supplied with RIVAL Front bumper 2D.4011.1-NL.

INSTALLATION PROCEDURE

Washer tank reservoir installation procedure



Fig.28

28. Displace rubber sealant of washer pump out of OE washer tank reservoir (fig.28).



Fig.29

29. Displace rubber sealant of washer liquid level sensor out of OE washer tank reservoir (fig.29).



Fig.30

30. Displace rubber sealant of washer tank reservoir filler out of OE washer tank reservoir (fig.30).



Fig.31

31. Install rubber sealant of washer pump on Washer tank reservoir (item. 12), (fig.31).



Fig.32

32. Install rubber sealant of washer liquid level sensor on Washer tank reservoir (item. 12), (fig.32).



Fig.33

33. Install rubber sealant of washer tank reservoir filler on Washer tank reservoir (item. 12), (fig.33).

INSTALLATION PROCEDURE



Fig.34

34. Install washer pump on Washer tank reservoir (item. 12), (fig.34).



Fig.35

35. Install liquid level sensor on Washer tank reservoir (item. 12), (fig.35).



Fig.36

36. Unscrew OE Bolt, disconnect the wiring and screw OE Bolt in back at the same hole (fig.36).

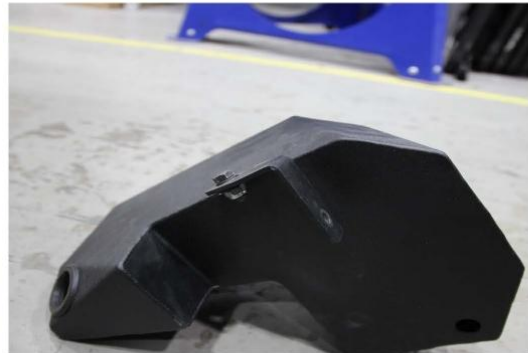

Fig.37

37. Install top washer tank reservoir bracket (item. 14) on washer tank reservoir (item. 12), using screw M6 (item. D), washer 6 (item. J) and nut M6 (item. G), (fig.37).



Fig.38

38. Install washer tank reservoir (item. 12) on the vehicle. Fix it using OE nut, screwed out on step 14 (fig.38). Don't forget to install OE terminal on the bolt, same as it was on the vehicle.



Fig.39

39. Install side washer tank reservoir bracket (item. 13) on washer tank reservoir (item. 12), using screw M6 (item. D), washer 6 (item. J), nut M6 (item. G) and bolt M6, screwed out on step 21 (fig.39).

INSTALLATION PROCEDURE

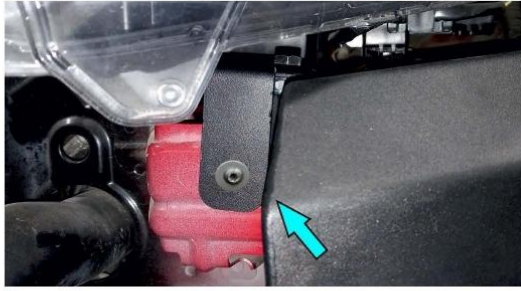

Fig.40

40. Fix washer tank reservoir (item. 12) on vehicle body, using screw M6 (item. D), washer 6 (item. J) and nut M6 (item. G), (fig.40).



Fig.41

41. Connect wiring to the reservoir pump and liquid level sensor, that were disconnected on steps 19-20 (fig.41).

Winch bracket installation procedure



Fig.42

42. Install insert nut M10 with cable (item. O) into the vehicle frame on both sides of the vehicle (fig.42).



Fig.43

43. Install winch bracket (item. 2) on the vehicle frame (fig.43).



Fig.44

44. Fix winch bracket (item. 2) to the OE front beam using bolts M10x1,25x35 (item. A) and washers 10 (item. K), (fig.44).

*** Do not tighten yet**

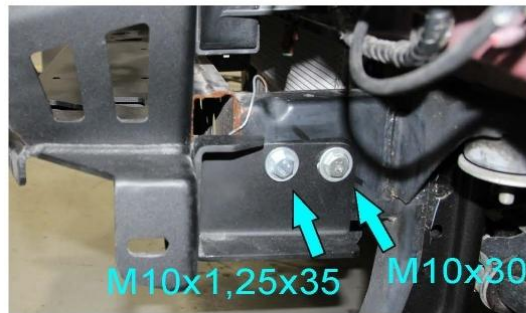

Fig.45

45. Install support brackets (item. 3 and 4) on the vehicle frame using bolts M10x1.25x35 (item. A), and to the insert nut M10 with cable (item. O) using bolts M10x30 (item. B) and washers 10 (item K) on both sides of the vehicle (fig.45). *** Do not tighten yet**

INSTALLATION PROCEDURE

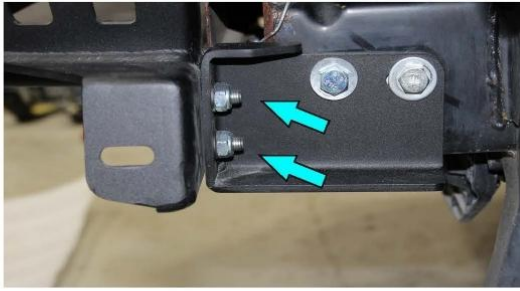

Fig.46

46. Fix support brackets (item. 3 and 4) on the winch bracket using bolts M10 (item. B), washers 10 (item. K) and nuts M10 (item, H). Align winch bracket (item. 2) on the vehicle frame (fig.46).

Tighten hardware, from steps 44-46, after that.



Fig.47

47. Install rear bash plate brackets (item. 8,9), fix it on the winch bracket (item. 2) using bolts M10 (item. B), washers 10 (item. K) and nuts M10 (item. H), (fig.47).



Fig.48

48. Install insert nuts M10 with cable (item. N) into rear bash plate brackets (item. 8,9), (fig.48).

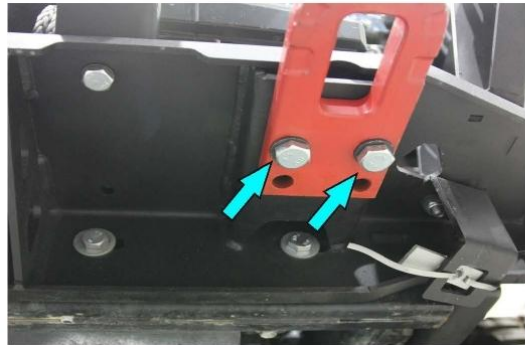

Fig.49

49. Install recovery points on winch bracket (item. 2). Fix it using bolts M12 (item. C) and washers 12 (item. L), (fig.49).



Fig.50

50. Install brackets for fairlead (item. 10,11) on winch bracket (item. 2), (fig.50).



Fig.51

51. Loosen bolts on the horn, if it's necessary, to adjust horn and install winch (fig.51).

INSTALLATION PROCEDURE

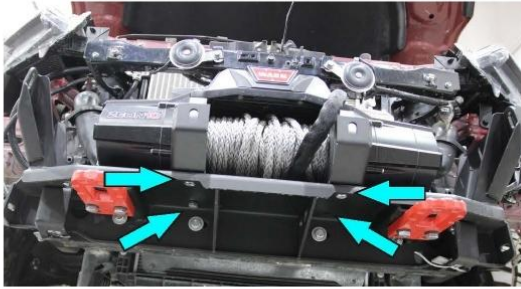

Fig.52

52. Install winch, fix it using bolts M10 (item. B) and washers 10 (item. K), through winch bracket (item. 2) and brackets for fairlead (item. 10,11), (fig.52).

Tighten horn and winch hardware after

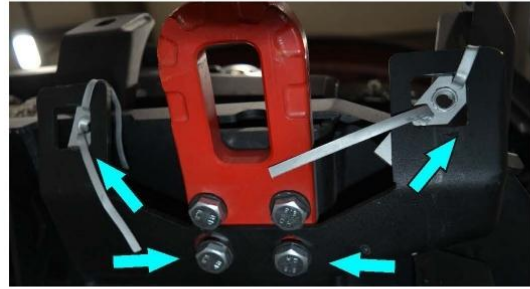

Fig.53

53. Install Front bash plate brackets (item. 6,7), fix to winch bracket (item. 2) using bolts M12 (item. C), washers 12 (item. L). Install insert nuts M10 with cable (item. N) into front bash plate brackets (item. 8,9), (fig.53).

Turn signal lights installation procedure



Fig.54

54. Disconnect all electronic connectors. Unscrew 4 screws retaining lights to OE bumper, on both sides of the vehicle, (fig.54).



Fig.55

55. Unscrew 3 screws on OE bumper, on both sides. Lift up grille and disconnect plastic clips retaining wiring (fig.55).

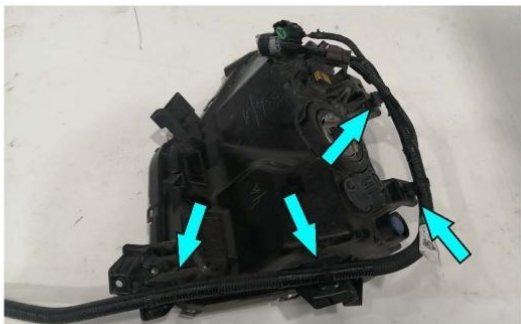

Fig.56

56. Remove plastic clips retaining lights wiring (fig.56).



Fig.57

57. Remove wiring from lights and bumper (fig.57).

INSTALLATION PROCEDURE

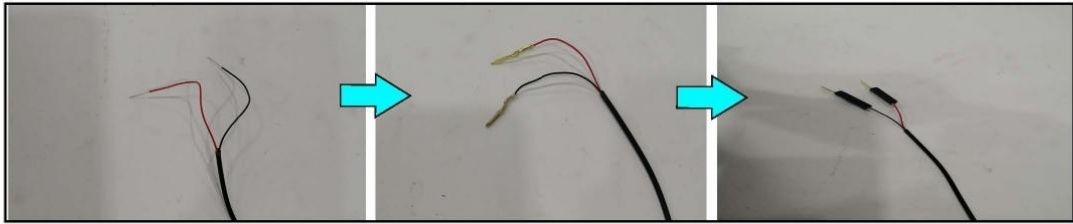

Fig.58

58. Crimp terminals (item. S) on blink lights (item. Q) wiring. Tape wiring using heat shrink tube (item. U), (fig.58).

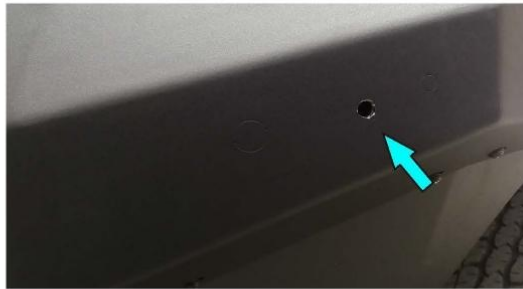

Fig.59

59. Locate knock-outs for blink lights on both sides of the bumper body (item.1), (fig.59).



Fig.60

60. Install blink lights (item. Q) into bumper body (item.1). Fix lights using nut, supplied with lights kit, on the inside of the bumper body (fig.60).

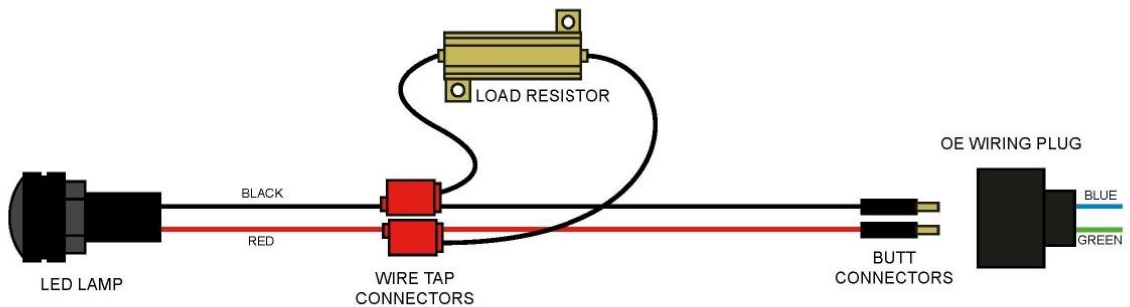

Fig.61

61. Connect resistor (item. R) to blink lights (item. Q) wiring using wire tap connectors supplied with resistor. Resistor connect parallel to blink lights (fig.61).

INSTALLATION PROCEDURE

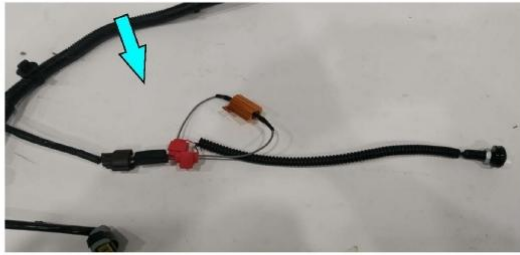

Fig.62

62. Place wiring into corrugated pipe (item. T). Connect terminals to OE lights wiring (fig.62).

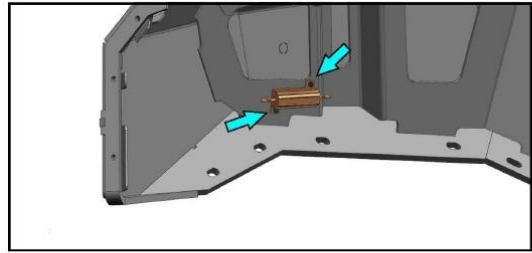

Fig.63

63. Fix wiring on the inside of bumper body (item. 1) using cable ties (item. M). Fix resistor on the inside of bumper body (item. 1) using screws M3 (item. V) and nut M3 (item. W) (fig. 63). Repeat on the other side of the vehicle.
NOTE: Resistor can get hot while operations.

Headlight washers installation procedure

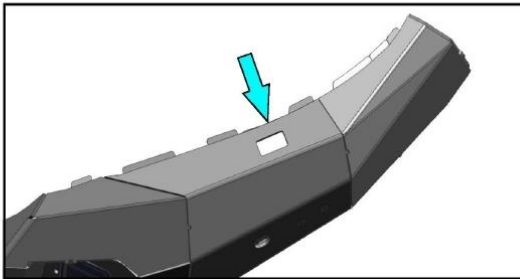

Fig.64

64. Locate knock-outs for headlight washers on the bumper body (item. 1) and knock them out by a hammer (fig. 64)

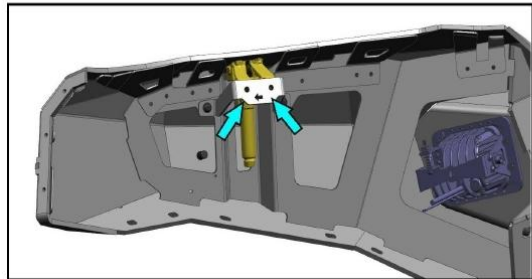

Fig.65

65. Install washer tank reservoirs and fix it on left and right headlight washer brackets (item. 17,18) using OE bolts (fig. 65).

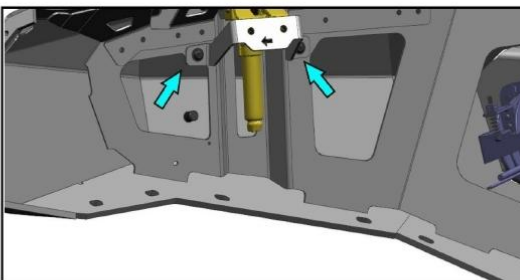

Fig.66

66. Fix left and right headlight washer brackets (item. 17,18) on bumper body (item.1) using screw M6 (item. D), washer 6 (item. I) and nut M6 (item. G), (fig.66).

INSTALLATION PROCEDURE

Bumper body installation procedure



Fig.67

67. Install bumper body (item. 1) onto winch bracket (item. 2) and fix it on both sides using:

1- Screws M10 (item. E), countersunk washers 10 (item. P), washers 10 (item. K) and nuts M10 (item. H)

2 – Bolts M10 (item. B), washers 10 (item. K) and nuts M10 (item. H), (fig.67).

* **Do not tighten yet**



Fig.68

68. Align the bumper body with the vehicle. Add adjusting plate 2mm (item. 27) or adjusting plate 3mm (item. 28) if it's necessary, between bumper body and winch bracket in fixation points (fig.68).

Tighten all the hardware from step 67 after that.



Fig.69

69. Fix your aftermarket LED cubic lights to brackets (item.23). These brackets are not compatible with flush mount LED lights (part number 2D.0041.1, purchased separately) (fig.69).



Fig.70

70. Install LED lights or LED Light caps (item. 24), using screw M6 (item. D), washer 6 (item. I) and LED brackets (item. 23) (fig.70).



Fig.71

71. Fix grill brackets (pos. 15, 16) to OE beam using OE screws that were unscrewed on step 11 (fig.71).

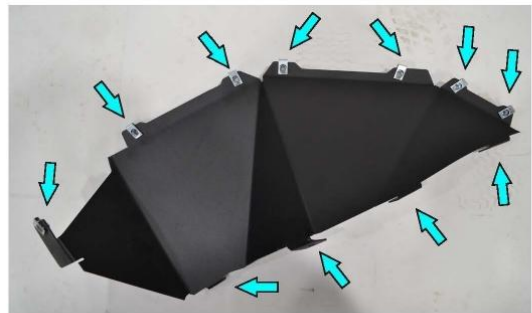

Fig.72

72. Install caged nuts (item. F) onto the flaps (item. 21,22) (fig.72).

INSTALLATION PROCEDURE



Fig.73

73. Install flaps (item. 21,22) using screw M6 (item. D), washer 6 (item. J) and nuts M6 (item. G) (fig. 73) onto the bumper body on each side.

Push the flap to plastic fender and mark future cutting line. Cut plastic fender following marked cutting line using jig-saw or shears (fig.73).



Fig.74

74. Mark and drill 4 holes in flap (item. 21,22) on each side of the vehicle. Fix flaps and fenders using screw M6 (pos. D), washer 6 (pos. J) and nuts M6 (item. G) (fig. 74).



Fig.75

75. Install bash plate (item. 20) using screw M10 (item. E) and countersunk washers 10 (item. P), (fig.75).



Fig.76

76. Install license plate bracket (item. 19) to bumper body (item.1) using screws M6 (item. D), washers 6 (item. I) and nuts M6 (item. G), (fig.76).



Fig.77

77. Install OE grill, that was removed on step 3 and fix bottom fixators into grille brackets (item. 15, 16), (fig.77).



Fig.78

78. Install plastic pad, that was removed on step 2. Connect terminal “-“ on the battery (fig.78).

INSTALLATION PROCEDURE

Before operating a vehicle fitted with RIVAL Bumper 2D.4011.1-NL:

- make sure all fittings are tightened
- check winch operation
- check that all electrical wiring is attached to the lights



Template 1

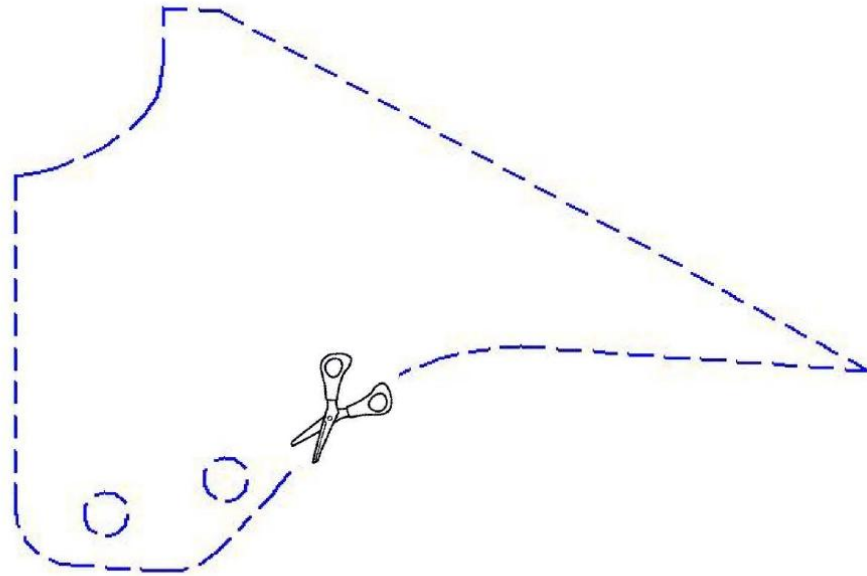

Template 2

